

Note: YKK has classified "PFAS compliant" fastening products as containing less than 50 ppm organic fluorine whereas "PFAS non-compliant" fastening products contain 50 ppm or more organic fluorine. However, please note that the definition of the term "PFAS compliant" does not imply conformity with a specific, or any, PFAS regulations in any country or region and that this definition of the term "PFAS compliant" may be subject to change based on trends and updates on PFAS regulations in any country or region.

Taiwan Collection SS26

Leaflet



PFAS-compliant



Sustainability



bluesign® approved



Water-repellent



YKK TAIWAN CO., LTD.

NATULON® Coil Zipper with Gradient Dual-colored TPU Puller

1. Gradient duo-colored TPU puller (code: TW427*) can also be customized upon requests, DTM available.
2. NATULON® product lines are designed for customers who want to increase the recycled content of their products. NATULON® Mechanically Recycled coil zippers are made from recycled materials such as PET bottles using mechanical recycling technologies. The yarn used in the tape of NATULON® Mechanically Recycled coil zipper is made from post-consumer recycled material.

CARE INFORMATION

Please note that this puller type does not meet the U.S. Consumer Product Safety Commission (CPSC) torque and tension standards and should not be used for children's product.

AVAILABILITY

Size	Chain type	Classification		
		Close	Open	Two-way
3	CF	OK	OK	OK
5	CI	OK	OK	OK

SLIDER AVAILABILITY

Size	Classification	Front/Reverse	Slider Type
5	CN	OK	DA8(B)/DAG8(B)/DA7B/DAG7B
5	VS	-	DA8/DAG8
5	M	-	DA8

COLOR VARIATION

Chain: Global Color Card, DTM available

TPU Puller: Global Color Card, DTM available

RECOMMENDED

Sports/Outdoor apparel, Casual

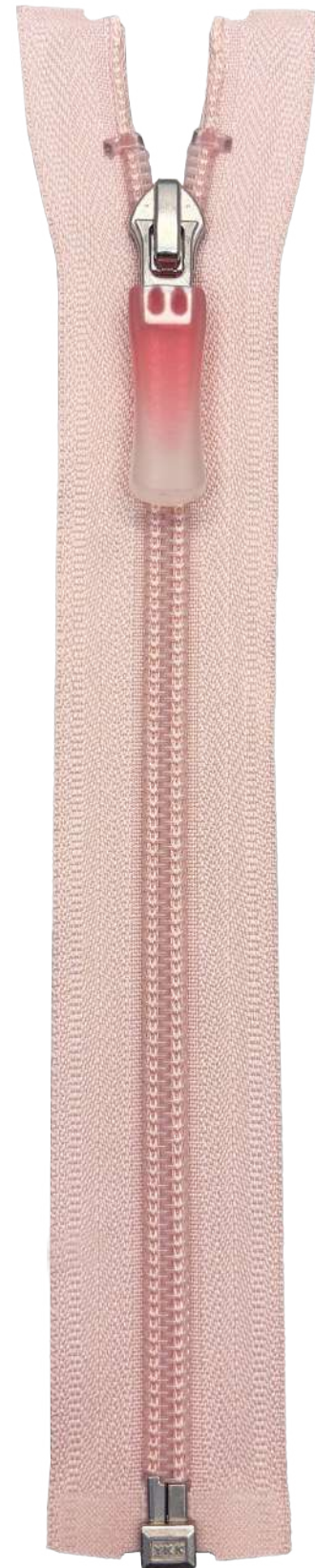

Code: CNLOR-56 DA8TW444B X6J PB16 EL-BK GREEN-F KENSIN MC-KWT1 N-ANTI P-TOP

NATULON® Coil Zipper with Glow-in-the-dark Sewing Thread and Soft Handfeel TPU Puller

1. Soft tactile sensation TPU with non-slip texture design (code:TW444*), puller can also be customized upon requests, DTM available.
2. Glow-in-the-dark sewing thread that lights up in the dark is available in 6 colors, matching the colors of the VISLON® zipper series.

CARE INFORMATION

Please note that this puller type does not meet the U.S. Consumer Product Safety Commission (CPSC) torque and tension standards and should not be used for children's product.

AVAILABILITY

Size	Chain type	Classification		
		Close	Open	Two-way
5	CNL	OK	OK	OK

SLIDER AVAILABILITY

Size	Classification	Front/Reverse	Slider Type
5	CN	OK	DA8(B)/DAG8(B)/DA7B/DAG7B
5	VS	-	DA8/DAG8
5	M	-	DA8
5	CC	-	DA

COLOR VARIATION

Tape: Global Color Card, DTM available

Elements: (YKK TWN) white, transparent, natural, black available

Sewing Thread: 6 colors available

TPU Puller: Global Color Card, DTM available



Natural



Green



Yellow



Orange



Pink

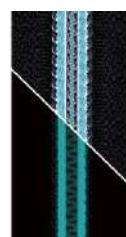

Natural

RECOMMENDED

Sports/Outdoor apparel, Casual



VISLON® NATULON® with Clear Reflective Film and Flat Stay Down Double Puller

1. Explore more than just reflectiveness with our innovative design. Now, not only does our reflective film enhance visibility, but it also showcases the intricate pattern designs and vibrant colors of the zipper tapes. Now also available in NATULON® zippers.
2. Flat stay down (code: DW1NT2), 10% thinner compared to standard DW slider. Featuring with flat stay down double-sided puller offers a stable grip without swaying, also possible to pair with cord attachments.



AVAILABILITY

Size	Chain type	Classification		
		Close	Open	Two-way
3	CF/VS	OK	OK	-
5	CNF/CNL/VS	OK	OK	-

SLIDER AVAILABILITY

Size	Classification	Slider Type
3	C/VS/CC	DW1
8	C	DW1



Flat Stay Down Slider for #3

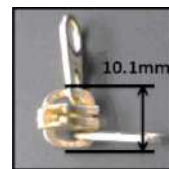

DW Slider for #3

COLOR VARIATION

Chain: Global Color Card, DTM available

Reflective Film: silver, black, gold, aurora, clear effect

Slider: Plating, enamel colors available

TPU Puller: Global Color Card, DTM available



Silver



Black



Gold



Aurora



Clear

RECOMMENDED

Sports/Outdoor apparel, Casual



TWSS26-04



Code: CNFC-56 DA9 RLV TR16 KENSIN N-ANTI T-B-0

Coil Zipper with Marble Tape and Vintage Effect Enameled Slider

1. Our specially crafted marble tape (code: TR**) adds a touch of sophistication to your garments by the distinctively elegant look of the tape. Available for metal, coil and VISLON® zippers.
2. Vintage-inspired surface treatment with abrasion finish (code: RLV), brings out a nostalgic charm and reminiscent of classic eras.



Marble-like texture



Abrasion Slider finish

Code: RLV

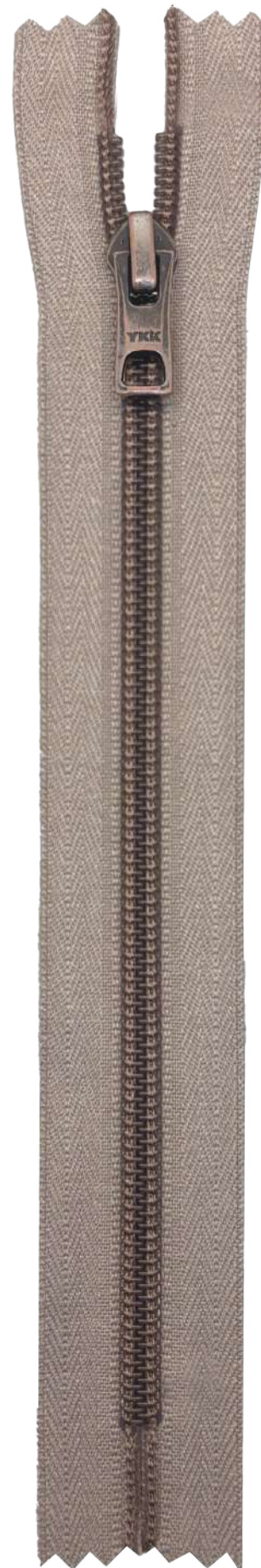

AVAILABILITY

Size	Chain type	Classification		
		Close	Open	Two-way
5	CIF/CNF	OK	OK	OK
5	R*	OK	OK	-
5	VS/VY*/VZ*	OK	OK	OK
8	VS/VY*	OK	OK	OK

COLOR VARIATION

Chain: (YKK TWN) Global Color Card, DTM available

RECOMMENDED

Sports/Outdoor apparel, Casual





Code: VYXMOVOL-59 DS5YG3 C5 PB14 BN-ANTI GREEN-F KENSIN LF-HOL NEWKOB4

bluesign® Approved METALUXE® NATULON® with Mirror Like Finish Elements

1. The METALUXE® zipper is now also available for bluesign® approved! Selected YKK products are available for bluesign® approved including zipper and plastic hardware. bluesign® approved item (code: BN-ANTI) is cost neutral with standard items.
2. Selected TPU and POM pullers are now also available for bluesign® approved. Please contact your YKK representative for additional information on bluesign® approved items.
3. The METALUXE® zipper is a VISLON® zipper that features a slimmer element shape and metallic element to achieve an elegant & luxurious metal look, with less weight as it uses plastic material instead of metal!

CARE INFORMATION

Please note that this puller type does not meet the U.S. Consumer Product Safety Commission (CPSC) torque and tension standards and should not be used for children's product.

COLOR VARIATION

Tape: Global Color Card, DTM available

Elements: 7 colors available



METALUXE® with Mirror Like Finish Elements

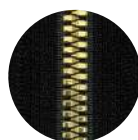

Gold

VYXMG
LF-GOL



Sliver

VYXMV
LF-SIL

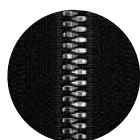

Chrome

VYXMJ
LF-CRO

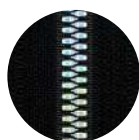

Hologram

VYXMV
LF-HOL

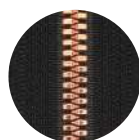

Copper

VYXMC
LF-COP



Matte Gold

VYXMG
LF-MATG

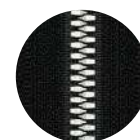

Matte Silver

VYXMV
LF-MATS

RECOMMENDED

Sports/Outdoor apparel, Casual



Sports/
Outdoor



Fashion

AVAILABILITY

Size	Chain type	Classification		
		Close	Open	Two-way
3	VYXM*	OK	OK	-
5	VYXM*	OK	OK	OK



Code: VZQOR-36 DALH EMJ PB12 BN-ANTI EL-COP4 GREEN-F KENSIN NEWKOB4

bluesign® Approved VISLON® Flat NATULON® with Metallic Color Elements

1. The VISLON® zipper and in-house production slider finishes including plating and enamel colors are now also available for bluesign® approved! Selected YKK products are available for bluesign® approved including zipper and plastic hardware. bluesign® approved item (code: BN-ANTI) is cost neutral with standard items.
2. Element shapes are stylishly designed, giving it a luxurious look.



COLOR VARIATION

Tape: Global Color Card, DTM available

Metallic Color Variation

						
Pink EL-PIK2	Copper EL-COP4	Light Green EL-GRN6	Emerald Green EL-GRN5	Blue EL-BLU9	Purple EL-VIO4	Antique Copper EL-COP5

RECOMMENDED

Sports/Outdoor apparel, Casual



AVAILABILITY

Size	Chain type	Classification		
		Close	Open	Two-way
3	VZ	OK	OK	-
5	VZ	OK	OK	OK

Code: CIBEOR-56 DA8BTW425 V3 PB16 BN-ANTI GREEN-F ND-B REVERSE TO-IPOM WATER-J

bluesign® Approved NATULON Plus® Coil Zipper with PFAS-compliant Coating and Texturized Puller

1. Selected YKK products are now bluesign® approved including zipper and plastic hardware. The NATULON Plus® coil zipper with PFAS compliant water repellent coating and in-house production slider finishes including plating and enamel colors are now also available for bluesign® approved. Please contact your YKK representative for additional information on bluesign® approved items. bluesign® approved item (code: BN-ANTI) is cost neutral with standard items.
2. The NATULON Plus® zipper features a higher ratio of recycled material by utilizing both recycled tape and elements. The NATULON Plus® zipper has the highest level of recycled material offered by YKK and can be further increased by pairing with a recycled diecast zinc slider! The material used in the coil zipper chain of the NATULON Plus® zipper is made from 100% post-consumer recycled material.
3. Texture puller design is customizable.



AVAILABILITY

Size	Chain type	Classification		
		Close	Open	Two-way
3	CFBE	OK	OK	OK
5	CIBE	OK	OK	OK

SLIDER AVAILABILITY

Size	Classification	Front/Reverse	Slider Type
5	CN	OK	DA8(B)/DAG8(B)/DA7B/DAG7B
5	VS	-	DA8/DAG8
5	M	-	DA8

COLOR VARIATION

Chain: Global Color Card, DTM available

Slider: plating, enamel colors available

RECOMMENDED

Sports/Outdoor apparel,
Casual, Backpack, Bags



Sports/
Outdoor



Fashion



Backpack

AquaGuard® NATULON® Coil Zipper with Bridge Top Stop

1. Bridge Top Stop series (code: TS-TIBR) now also available with PFAS compliant water repellent coating. This top stop design not only removes the necessity for a zipper garage on garments but also achieves a sleek and minimalist look. It enhances water repellency and aesthetics by eliminating the gap between coil elements and top stop.

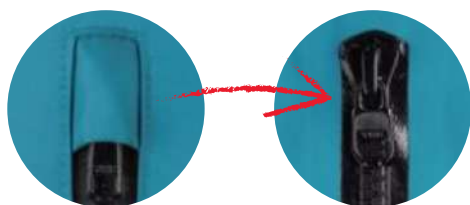

Enhances water repellency and achieves a sleek look.



Zipper length is measured from the top of slider to the end of element/top of bottom stop for VISLON® zippers.



AVAILABILITY

Size	Chain type	Classification		
		Close	Open	Two-way
3	CZT8/10	OK	-	-
3	VT8/10	OK	-	-
5	VT8/10	OK	-	-

SLIDER AVAILABILITY

Size	Classification	Front/Reverse	Slider Type
3	C	REVERSE only	3C DFB/DS15V/DF15V
3	VS	-	3VS DA/DF
5	VS	-	5VS DA/DF

COLOR VARIATION

Chain: Global Color Card available

Top/Bottom stops: Black only

RECOMMENDED

Sports/Outdoor apparel, Casual



VISLON® NATULON® with Revived Top Stop

1. New top stop (code: TS-POM2) offers an easier solution for removing and reattaching sliders. This option simplifies slider repair and replacement, contributes to garment longevity, leading to better sustainability. With the innovative track design, this top stop facilitates the slider repair process without necessitating the replacement of the entire zipper in case of slider/puller damage. Ideal for garment repair needs such as in high-end outdoor lines.

CARE INFORMATION

1. The VISLON® zipper with revived top stop is not available for children’s clothing.
2. To prevent accidental ingestion, keep slider and puller used in this product out of the reach of children.

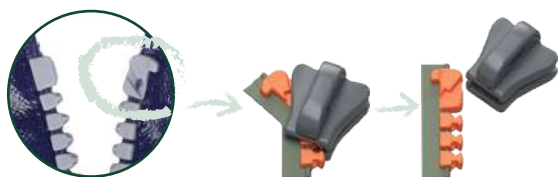

Simply remove the slider by following the track design.



↑ Sewing precaution and more information

AVAILABILITY

Size	Chain type	Classification		
		Close	Open	Two-way
5	VT8/10	-	OK	-
5	VS	-	OK	OK

COLOR VARIATION

Chain: Global Color Card available

RECOMMENDED

Sports/Outdoor apparel, Casual

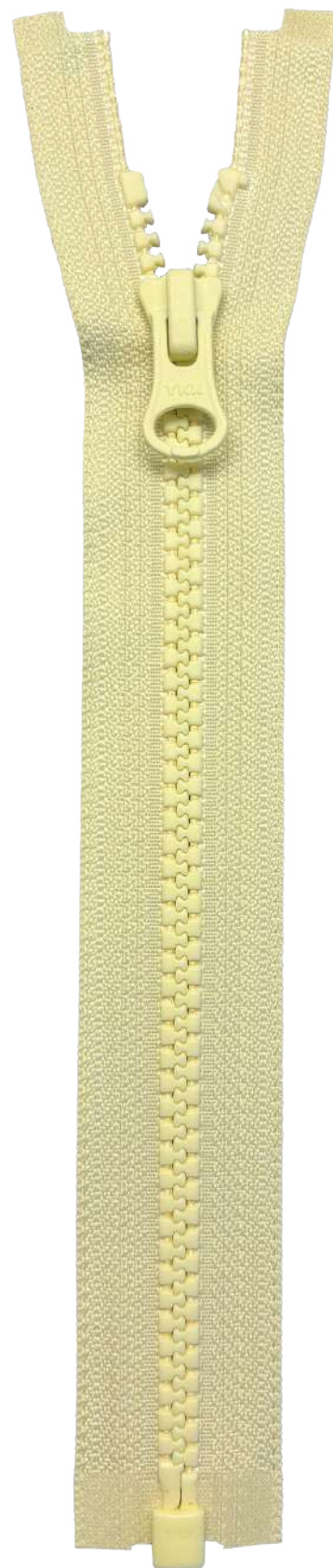

TWSS26-10



Code: 10 CFT14 CHAIN R19J DYED GREEN-F HANK100

AquaGuard® NATULON® Coil Zipper with PFAS-compliant Coating No.10

1. YKK's AquaGuard® water repellent zipper series now also available in No.8 and No.10! Transparent shiny (T14) and matte (T15) effect type available. Now featured in NATULON® zippers and PFAS compliant water repellent coating.

COLOR VARIATION

Shiny (CFT14), Matte (CFT15)

Chain: Global Color Card available



Shiny
Transparent
CFT14



Matte
Transparent
CFT15

RECOMMENDED

Luggage, Bags, Equipment



↑More information

AVAILABILITY

Size	Chain type	Classification			
		Close	Open	Two-way	Chain
8	CFT14/15	OK	-	-	OK
10	CFT14/15	-	-	-	OK



TWSS26-11



Code: 10 CFT15 CHAIN R19J DYED GREEN-F HANK100

AquaGuard® NATULON® Coil Zipper with PFAS-compliant Coating No.10

1. YKK's AquaGuard® water repellent zipper series now also available in No.8 and No.10! Transparent shiny (T14) and matte (T15) effect type available. Now featured in NATULON® zippers and PFAS compliant water repellent coating.

COLOR VARIATION

Shiny (CFT14), Matte (CFT15)

Chain: Global Color Card available



Shiny
Transparent
CFT14



Matte
Transparent
CFT15

RECOMMENDED

Luggage, Bags, Equipment



↑More information

AVAILABILITY

Size	Chain type	Classification			
		Close	Open	Two-way	Chain
8	CFT14/15	OK	-	-	OK
10	CFT14/15	-	-	-	OK



Code: 05 RCF CHAIN PB16 DYED GREEN-F HANK200 WATER-J
05 RC DF36B C5 PARTS BOX KENSIN N-ANTI

NATULON® Racquet Coil Zipper with PFAS-compliant Coating

1. The racquet coil zipper is now also available in NATULON® zippers and PFAS compliant water repellent coating! YKK's racquet coil zipper is specially designed for luggage and backpack where resistance to abrasion is a must. This zipper was precision engineered to meet the toughest performance requirements.



COLOR VARIATION

Chain: Global Color Card available
Slider: plating, enamel colors available

RECOMMENDED

Luggage, Bags, Equipment



This slider offers a flatter profile compared to the standard DFB; crown part is aligned vertically to the chain, suitable for application with cord puller.

AVAILABILITY

Size	Chain type	Classification			
		Close	Open	Two-way	Chain
5	RCF	-	-	-	OK
8	RCF	-	-	-	OK

SLIDER AVAILABILITY

Size	Classification	Front/Reverse	Slider Type
3	C	REVERSE only	DF36B/DF36V
5	RC	REVERSE only	DF36B
8	RC	REVERSE only	DF36B



TWSS26-13

PFAS
Compliantbluesign®
APPROVEDCode: LB16GVW POM BUCKLE PLUG & WHISTLE
LB16GVA POM BUCKLE SOCKET & ADJUSTER

Single Release Whistle Buckle with Tri Bar Adjuster

1. The unique spring design provides higher durability and soft release features. It also has the whistle function for the plug part and combines with the loop adjuster for the socket portion.
2. LB-GV* series is bluesign® approved and POM material is GRS certified.

**Conventional product**
<YKK comparison>

+

**Whistle Buckle****Tri Bar Adjuster****Code: LB-GV****Code: LB-GVP****Code: LK-GV**

COLOR VARIATION

DTM available

ITEM AVAILABILITY

Sizes: 16 mm

Material: Polyacetal (POM) or Recycled POM

RECOMMENDED

Backpack, Sports Bags
Messenger Bags

Backpack

*GV series each offers unique functionalities,
also compatible with combined usage for
optimal performance.

TWSS26-14



Code: LB38ND POM BUCKLE

Single Release Swivel Buckle

1. Latest buckle which combines the convenience of easy release with the versatility of a rotatable design, featuring both D-ring and snap hook functions.
2. The newly developed top closure can be easily released with one hand.
3. POM material is GRS certified.



Conventional product
<YKK comparison>



New Style Swivel Buckle

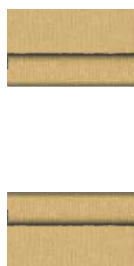

COLOR VARIATION

DTM available

ITEM AVAILABILITY

Sizes: 25*/38 mm

*25 mm currently under development until end of 2024.

Material: Polyacetal (POM) or Recycled POM

RECOMMENDED

Backpack, Sports Bags,
Messenger Bags



press here for easy release



The convenience of easy release with the versatility of a rotatable design, featuring both D-ring and snap hook functions.

TWSS26-15

PFAS
Compliant

bluesign
APPROVED

Code: LK03MH POM ADJUSTER

Strap Adjuster

1. Adjuster with hook for cords. In the movable shaft mechanism, the movable shaft is pulled evenly to keep strength consistent and stable. Also, when the cord is pulled, the structure naturally divides the cord left and right along the angled surfaces.
2. This product is bluesign® approved.



COLOR VARIATION

DTM available

ITEM AVAILABILITY

Sizes: 3 mm

Material: Polyacetal (POM) or Recycled POM

RECOMMENDED

Backpack, Sports Bags,
Messenger Bags



↑ More
information



TWSS26-16



Code: LN38UMN SC-POM NOISE-LESS HOOK

Snap Hook

1. The roof top is constructed to allow two types of tape to pass through.
2. Slick material is used to "reduce squeaking noise" when rotating.

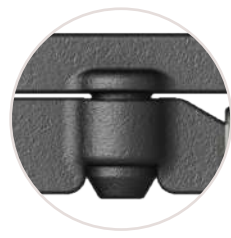
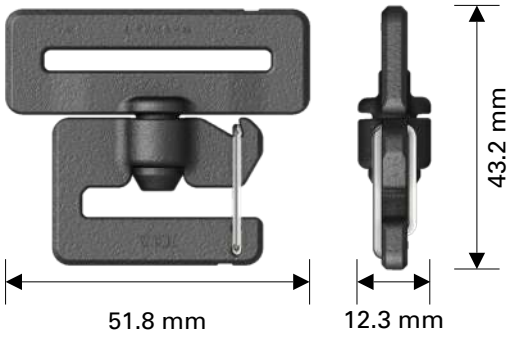

Slick material is used to "reduce squeaking noise" when rotating.

COLOR VARIATION
DTM available

ITEM AVAILABILITY
Sizes: 38 mm
Material: Polyacetal (POM) or Recycled POM

RECOMMENDED
Backpack, Messenger Bags  Backpack

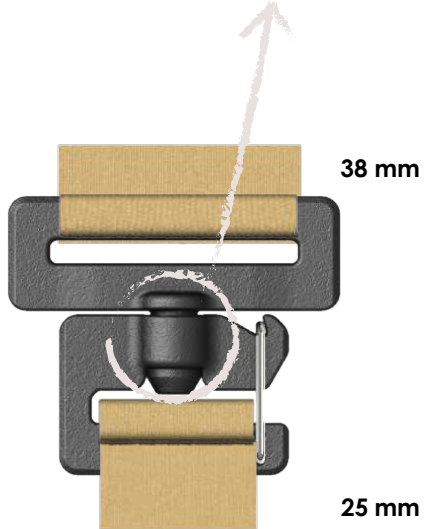

This snap hook is constructed to allow two types of tape to pass through.